

Vegetable Slicer

TRS Vegetable Bench Cutter with Ejector - US Plug

ITEM # _____

MODEL # _____

NAME # _____

SIS # _____

AIA # _____



Short Form Specification

Item No. _____

Universal vegetable preparation machine for more than 80 different types of cuts. Stainless steel motor casing. Removable cover and feed arm in polished cast aluminium with incorporated magnetic safety device which only allows the cutter to operate if the hopper is closed. No volt release system. Self braking motor.

Main Features

- Suitable for 100-300 meals for table service and up to 600 meals for catering service.
- Vegetable slicer unit has slicing, grating, shredding (julienne) as well as dicing and french fries capabilities.
- Delivered with: polished cast aluminium vegetable preparation attachment with a lever-integrated long vegetable hopper 2" diameter (52mm) and a large half moon hopper 6"x3" (154x77mm).
- Ergonomically design to work frontally and to reduce the working space around the machine.
- Hopper easily removed for cleaning.
- Base inclined at 20° to provide easy loading and unloading.
- Complete and wide selection of blades and grids available, Diameter of blades and grids are 8" (205mm).
- Magnetic safety system and motor brake. Prevents machine from running when lever swings away or is open.
- Automatic restart of the machine with the half-moon shaped lever in position.
- Continuous feed model.

Construction

- Asynchronous industrial motor with no brushes for high reliability and quiet functioning, stainless steel motor shaft.
- 1 speed: 400 rpm - for precise cutting, slicing and dicing.
- IP55 waterproof ON/OFF buttons, IP24 throughout the entire machine.
- Compact and portable design.

Optional Accessories

- Stainless steel work table assembly. PNC 653283
- Dicing Grid 3/16" x 3/16" (5 x 5mm) PNC 653566
 (can be combined with Slicing Discs [C] and Wavy Slicing Discs (CW))
- Dicing Grid 5/16" x 5/16" (8 x 8mm) PNC 653567
 (can be combined with Slicing Discs [C] and Wavy Slicing Discs (CW))
- Dicing Grid 3/8" x 3/8" (10 x 10mm) PNC 653568
 (can be combined with Slicing Discs [C] and Wavy Slicing Discs (CW))
- Dicing Grid 15/32" x 15/32" (12 x 12mm) (can be combined with Slicing Discs [C] and Wavy Slicing Discs (CW)) PNC 653569

APPROVAL: _____



- Dicing Grid 25/32" x 25/32" (20 x 20mm) (can be combined with Slicing Discs [C] and Wavy Slicing Discs (CW)) PNC 653570
- Grid for Chips 1/4" (6mm) (can be combined with Slicing Discs [C] and Wavy Slicing Discs (CW)) PNC 653571
- Grid for Chips 5/16" (8mm) (can be combined with Slicing Discs [C] and Wavy Slicing Discs (CW)) PNC 653572
- Grid for Chips 3/8" (10mm) (can be combined with Slicing Discs [C] and Wavy Slicing Discs (CW)) PNC 653573
- Grating Disc 5/64" (2mm) PNC 653773
- Grating Disc 1/8" (3mm) PNC 653774
- Grating Disc 5/32" (4mm) PNC 653775
- Grating Disc 9/32" (7mm) PNC 653776
- Grating Disc 11/32" (9mm) PNC 653777
- Grating Disc for breadcrumbs/potatoes PNC 653778
- Grating Disc for parmesan/chocolate PNC 653779



Electrolux
PROFESSIONAL

Vegetable Slicer TRS Vegetable Bench Cutter with Ejector - US Plug

Front

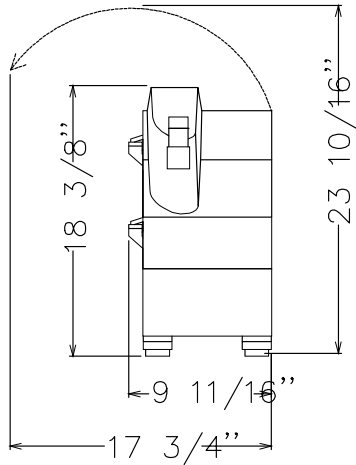

Side

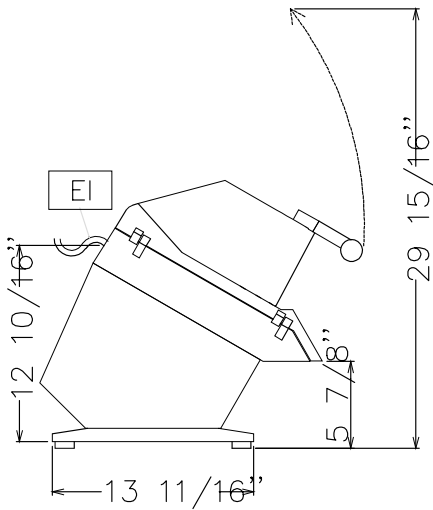

EI = Electrical connection

Top

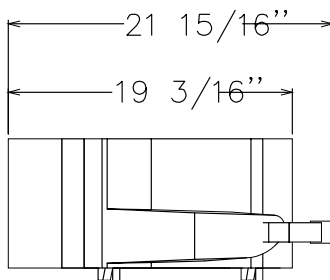

Electric

Supply voltage:

603805 (TR24SNU) 115 V/1N ph/60 Hz

Electrical power, max:

0.64 kW

Total Watts:

0.64 kW

Capacity:

Performance (up to):

450 kg/hour

Key Information:

External dimensions, Width: 246 mm

External dimensions, Depth: 557 mm

External dimensions, Height: 466 mm

Shipping weight: 27 kg

Vegetable Slicer
TRS Vegetable Bench Cutter with Ejector - US Plug

The company reserves the right to make modifications to the products without prior notice. All information correct at time of printing.

2024.12.21